

Varenummer: 0108045
 Beskrivelse: Seeger låsering JK 28 DIN 984

Mål

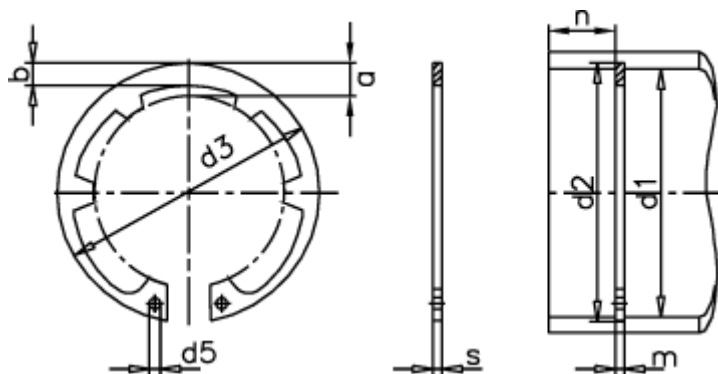

a max	= 4.9	d5 min	= 2.0	s	= 1.20
AN mm ²	= 63.1	FN kN	= 10.5	t	= 0.70
Antal takker	= 6	FRg kN	= 4.5	Tang	= ZGJ-2
b	= 3.0	FR kN	= 13.3	tol	= -0.06
Betegnelse	= JK 28	g	= 1.0	tol	= +0,50-0,25
d1	= 28	K kN-mm	= 26.3	tol	= +0,21
d2	= 29.4	m min	= 1.30	vægt kg/1000	= 2.10
d3	= 30.1	Nominal træk	= 2.1		